

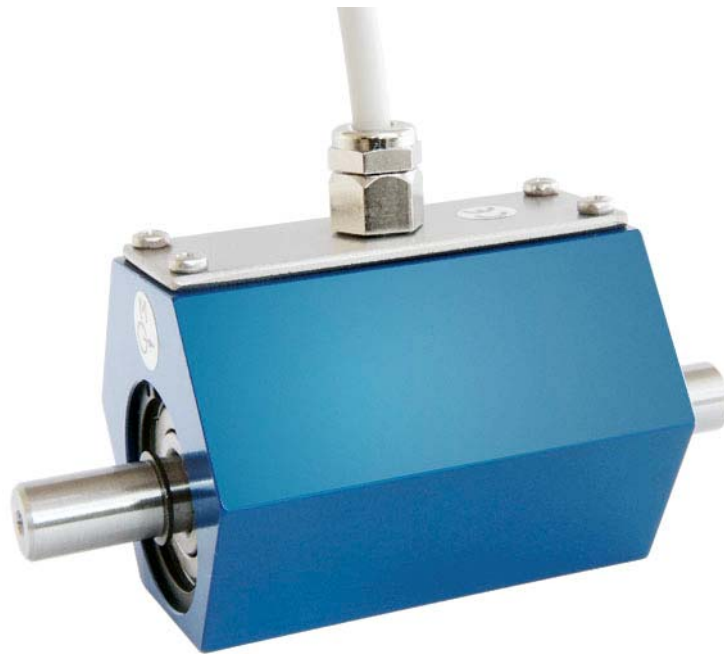

Operation Manual for Torque Sensors

For Type DR-2477





Imprint

Manufacturer, Place	Lorenz Messtechnik GmbH, D-73553 Alfdorf.
Valid for...	Torque sensor type DR-2477
Copyright	© 2006 Lorenz Messtechnik GmbH, Alfdorf.
Reprint Interdiction	Reprints, even in extracts, only with written authority.
Modification	Technical changes reserved.

References in this Text

1.6 Warning Notes, Page 4



Attention must be paid to the accident prevention regulations of the trade associations. Coverings and casings are necessary before operating the sensor. This is also valid for commissioning, maintenance and trouble shooting.

Duties of the coverings and casings are:

- ⇒ Protection from detaching parts
- ⇒ Protection from contusion and shear
- ⇒ Prevention from reaching rotating parts
- ⇒ Prevention from being tangled up and/or getting caught by parts

Coverings may

- ⇒ Not grind
- ⇒ Not rotate

Coverings are also necessary outside of operating and motion travel areas of persons. These demands can be modified if other sufficient safety devices are available. During operation, the safety precautions must be operative. By vibrations, damages can occur at the device.

4.1.3 Alignment of the Measurement Arrangement; Page 6



For further references see coupling manual.

4.2 General; Page 6



Before the assembly, shafts must be cleaned with dissolver (e.g. acetone), no foreign particles may adhere to them. The hub must fit corresponding to the connection.



During the assembly, the sensor must be supported to protect it from falling down.



Caution: During the assembly inadmissibly large forces may not act on the sensor or the couplings.

4.2.1 Torque Sensors below 20 N.m; Page 7



Sensors with nominal torques below 20 N·m are very sensitive to overload, therefore these sensors need to be handled with greatest caution.

4.3 Freefloating Assembly; Page 7



In this installation case, double-jointed couplings can not be used for both sides!
Risk of Breakage!

6.1 Engaging; Page 9



Warming-up period of the torque sensor is approx. 5 min.

6.4.2 Natural Resonances; Page 10



An operation of the device in natural resonance can lead to permanent damages.



Contents

1	Read First.....	4
1.1	Safety and Caution Symbols.....	4
1.2	Intended Use.....	4
1.3	Dangers.....	4
1.3.1	Neglecting of Safety Notes	4
1.3.2	Remaining Dangers	4
1.4	Reconstructions and Modifications	4
1.5	Personnel	4
1.6	Warning Notes	4
2	Term Definitions	5
2.1	Terms	5
2.2	Definition of the Pictograms on the Torque Sensor.....	5
3	Product Description	5
3.1	Mechanical Setup.....	5
3.2	Electrical Setup	6
4	Mechanical Assembly.....	6
4.1	Couplings	6
4.1.1	Misalignment Possibilities of Single-Jointed Couplings.....	6
4.1.2	Double-Jointed Couplings.....	6
4.1.3	Alignment of the Measurement Arrangement.....	6
4.2	General	6
4.2.1	Torque Sensors below 20 N·m	7
4.2.2	Torque Sensors from 20 N·m and above	7
4.3	Freefloating Assembly	7
4.4	Foot Version Assembly	8
5	Electrical Connection.....	8
5.1	Pin Connection.....	8
5.2	Cable.....	8
5.3	Shielding Connection	8
5.4	Running of Measuring Cables.....	8
6	Measuring.....	9
6.1	Engaging.....	9
6.2	Direction of Torque.....	9
6.3	Static / Quasi-Static Torques	9
6.4	Dynamic Torques	9
6.4.1	General	9
6.4.2	Natural Resonances	9
6.5	Speed Limits	9
6.6	Disturbance Variables.....	9
7	Maintenance.....	10
7.1	Maintenance Schedule	10
7.2	Trouble Shooting.....	10
8	Decommission.....	10
9	Transportation and Storage	10
9.1	Transportation	11
9.2	Storage.....	11
10	Disposal	11
11	Calibration.....	11
11.1	Proprietary Calibration.....	11
11.2	DKD-Calibration.....	11
11.3	Re-Calibration.....	11
12	Data Sheet.....	11
13	Literature.....	11



1 Read First

1.1 Safety and Caution Symbols

**Caution:**

Injury Risk for Persons
Damage of the Device is possible.

**Note:**

Important points to be considered.

1.2 Intended Use

Torque sensors are intended for the measurement of torques. This measurand is further suitable for control tasks. The valid safety regulations should be absolutely respected. The torque sensors are not safety components in the sense of the intended use. The sensors need to be transported and stored appropriately. The assembly, commissioning and disassembling must take place professionally.

1.3 Dangers

The torque sensor is fail-safe and corresponds to the state of technology.

1.3.1 Neglecting of Safety Notes

At inappropriate use, remaining dangers can emerge (e.g. by untrained personnel). The operation manual must be read and understood by each person entrusted with the assembly, maintenance, repair, operation and disassembly of the torque sensor.

1.3.2 Remaining Dangers

The plant designer, the supplier, as well as the operator must plan, realize and take responsibility for safety-related interests for the sensor. Remaining dangers must be minimized. Remaining dangers of the torque measurement technique must be pointed out.

Human mistakes must be considered. The construction of the plant must be suitable for the avoidance of dangers. A danger-analysis for the plant must be carried out.

1.4 Reconstructions and Modifications

Each modification of the sensors without our written approval excludes liability on our part.

1.5 Personnel

The installation, assembly, commissioning, operation and the disassembly must be carried out by qualified personnel only. The personnel must have the knowledge and make use of the legal regulations and safety instructions.

1.6 Warning Notes



Attention must be paid to the accident prevention regulations of the trade associations.

Coverings and casings are necessary before operating the sensor. This is also valid for commissioning, maintenance and trouble shooting.

Duties of the coverings and casings are:

- ⇒ Protection from detaching parts
- ⇒ Protection from contusion and shear
- ⇒ Prevention from reaching rotating parts
- ⇒ Prevention from being tangled up and/or getting caught by parts

Coverings may

- ⇒ Not grind
- ⇒ Not rotate

Coverings are also necessary outside of operating and motion travel areas of persons. These demands can be modified if other sufficient safety devices are available. During operation, the safety precautions must be operative. By vibrations, damages can occur at the device.



2 Term Definitions

2.1 Terms

Measuring Side:

Mechanical connection of the torque sensor in which the torque to be measured is applied. Usually this side has the smallest moment of inertia.

Drive Side:

Mechanical connection of the torque sensor on the opposite side of the measuring side, usually with the largest moment of inertia. At static torque sensors the housing is fastened on this side.

Low Torque Resistance Side:

The shaft of the arrangement (drive, load) which can be turned considerably smaller with torque than the nominal torque of the torque sensor $M \ll M_{nenn}$.

2.2 Definition of the Pictograms on the Torque Sensor

The measuring side of the torque sensor is designated as follows:

Measuring side:  or M

More information can be found on the data sheet, if needed.

3 Product Description

The sensor measures static and dynamic torques. The mounting position of the torque sensor is horizontally.

Caution: it is to be differentiated between measuring side and drive side, see data sheet of the sensor: <http://www.lorenz-sensors.com>

3.1 Mechanical Setup

The sensors consist of a torsion shaft with free round shaft ends. The torsion shaft, applied with two strain gauge full bridges, is bedded in a housing through ball bearings. For the signal transmission and/or the supply of the strain gauge full bridges, a rotating transformer, according to the principle of a transformer, is arranged in the sensor. For supply and measuring signal conditioning, electronics are integrated in the stator and the rotor.

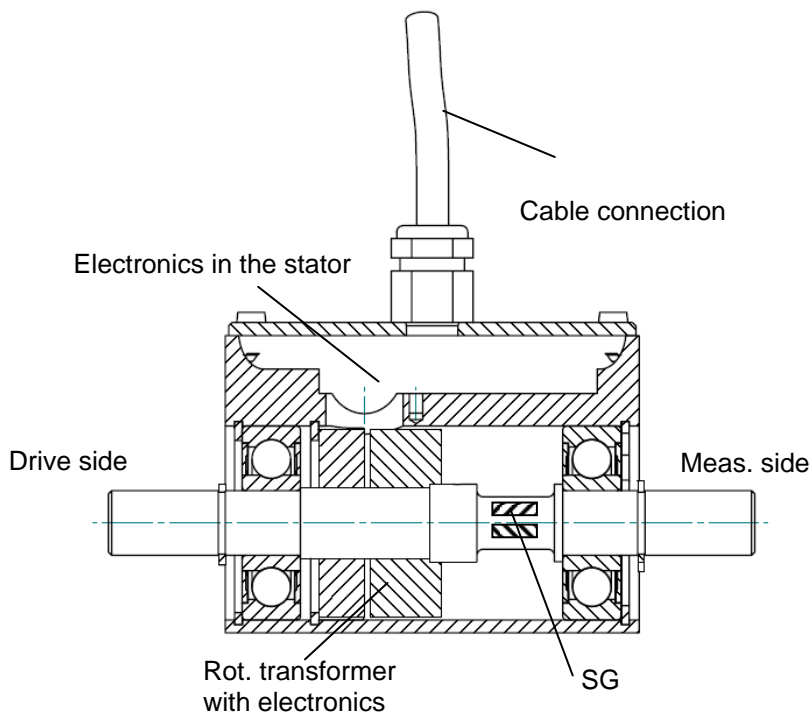



3.2 Electrical Setup

The electronics integrated in the sensor consists of two parts.
The first part is in the stator and has following tasks:

- Stabilization of the supply voltage
- Electric supply of the rotor electronics through the rotating transformer
- Preparation of the measurement signal from the rotor
- Readout of the torque measurement signal to the cable connection

The second part of the electronics is placed in the rotor of the torque sensor and has following functions:

- Supply of the SG full bridge with d.c. voltage
- Preparation of the electrical torque measurement signal
- Transmission of the measurement signal to the stator

4 Mechanical Assembly

For the assembly of a torque sensor in a shaft line, we always recommend to use couplings which can be misaligned.

4.1 Couplings

We recommend multi-disc couplings for our torque sensors. Couplings must be able to balance an axial, radial or angular offset of the shafts and not allow large forces to act on the sensor. The assembly instructions of the respective coupling manufacturer must be considered.

4.1.1 Misalignment Possibilities of Single-Jointed Couplings

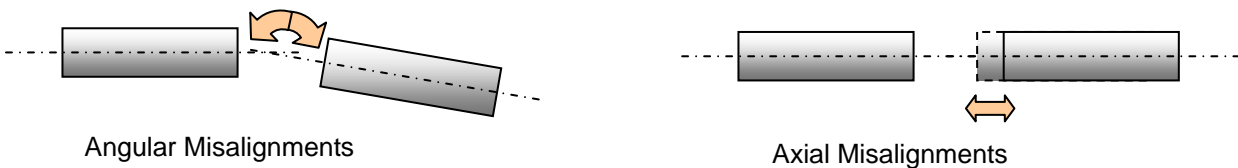

Note: Radial misalignments are only possible in the combination of single-jointed coupling - torque sensor (as adapter) - single-jointed coupling. Thus, with both single-jointed couplings the torque sensor forms a double-jointed coupling.

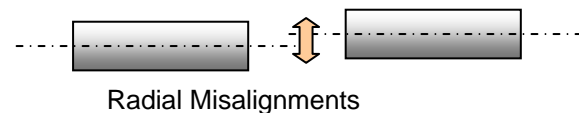

4.1.2 Double-Jointed Couplings

Double-jointed couplings are used for the balance of inevitable angular, axial and radial misalignments.

4.1.3 Alignment of the Measurement Arrangement

Precisely alignment of the couplings reduces the reaction forces and increases the durability of the couplings. Disturbance variables are minimized as well.

Due to the multitude of applications, an alignment of the coupling with a straight edge in two levels, vertical to each other, is sufficient.

However, in drives with high speed an alignment of the coupling (shaft ends) with a dial gauge or a laser is recommended.



For further references see coupling manual.

4.2 General



Before the assembly, shafts must be cleaned with dissolver (e.g. acetone), no foreign particles may adhere to them. The hub must fit corresponding to the connection.



During the assembly, the sensor must be supported to protect it from falling down.



Connections with Clamping Piece:

The indications of the clamping piece manufacturer must be considered. The clamping piece must be able to transfer the arising torques safely.



Caution: During the assembly inadmissibly large forces may not act on the sensor or the couplings. At small torques (< 20 N·m) connect the sensor electrically during the assembly and observe the signal, the measurement signal may not exceed the limit values

4.2.1 Torque Sensors below 20 N·m



Sensors with nominal torques below 20 N·m are very sensitive to overload, therefore these sensors need to be handled with greatest caution.

1. Connect the sensor electrically during the assembly and observe the measuring signal; the limit values may not be exceeded in any case.
2. Align the arrangement before the parts are connected firmly.
3. Assemble the sensor at the low torque resistance side first, then at the stationary side (this avoids impermissibly large torques from acting on the sensor).
4. Counter-hold by hand, so that impermissibly large torques or disturbance variables can not act on the torque sensor.

4.2.2 Torque Sensors from 20 N·m and above

The hub must fit corresponding to the connection.

4.3 Freefloating Assembly

The sensor is installed between two single-jointed couplings and contributes to the balance of an inevitable axis offset between the two mechanical connections.

If no couplings are used, very large transverse forces can affect the sensor. In addition, large forces occur on the bearings, in drive and output, which limit their life span very strongly.

Shafts must be cleaned with solvent (e.g. acetone) before the assembly. No foreign particles may adhere to them.

Shift couplings on shafts (use entire clamping length of the coupling) and align shafts. Absolutely assure that the data of the couplings (axis offset, angular offset, tension, compression) are not exceeded.

The housing must be protected from twisting e.g. by a flexible connection. The cable connection may not be used for this.

The cable connection must be placed loosely (form of goose neck), so that it can follow the light movements of the stator.

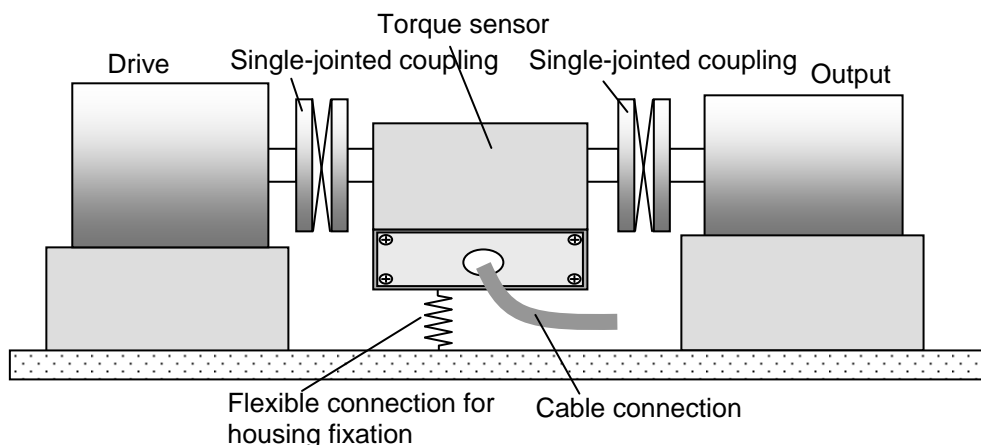

In this case, with both single-jointed couplings, the torque sensor forms a double-jointed coupling. A single-jointed coupling can only balance axial and angular misalignments.



Risk of Breakage! In this installation case, double-jointed couplings can not be used for both sides!



4.4 Foot Version Assembly

The sensor can be installed as a bearing block. A double-jointed coupling must be mounted on each shaft end. By this, inevitable axis offsets, which can also appear during the period of operation, are being balanced. If no couplings are used, very large transverse forces can occur in the bearings of the sensor as well as in the bearings on drive and output which will limit their life span very strongly. Further, large bending moments will emerge in the shaft.

At small torques (< 20 N·m) connect the sensor electrically and observe the signal; the measurement signal may not exceed the limit values..

Shafts must be cleaned with solvent (e.g. acetone) before the assembly. No foreign particles may adhere to them.

Shift couplings on shafts (use entire clamping length of the coupling) and align shafts. Absolutely assure that the data of the couplings (axis offset, angular offset, tension, compression) are not exceeded.

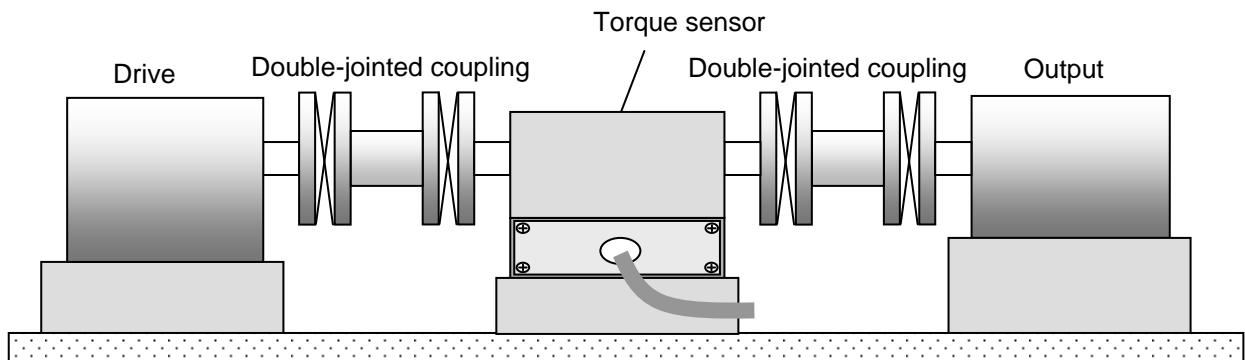

5 Electrical Connection

5.1 Pin Connection

Also see test certificate.

The firmly connected cable has free ends

Green	Excitation GND	0 V
Brown	Excitation +	12 ... 28 VDC
Yellow	Signal	±5 V / (±10 V)
White	Signal GND	0 V
Netting	Shield	

5.2 Cable

Only use a shielded cable with preferably small capacity. We recommend measuring cables from our product range. They have been tested in combination with our sensors and meet the metrological requirements.

5.3 Shielding Connection

In combination with the sensor and the external electronics, the shield forms a Faraday Cage. By this, electro-magnetic disturbances do not have any influence on the measurement signal.

5.4 Running of Measuring Cables

Do not run measuring cables together with control or heavy-current cables. Always assure that a large distance is kept to engines, transformers and contactors, because their stray fields can lead to interferences of the measuring signals.

If troubles occur through the measuring cable, we recommend to run the cable in a grounded steel conduit.



6 Measuring

6.1 Engaging

The warming-up period of the torque sensor is approx. 5 min. Afterwards the measurement can be started.



The warming-up period of the torque sensor is approx. 5 min.

6.2 Direction of Torque

Torque means clockwise or counter-clockwise torque if the torque acts clockwise when facing the shaft end. In this case a positive electrical signal is obtained at the output.

Torque sensors by Lorenz Messtechnik GmbH can measure both, clockwise and counter-clockwise direction.

6.3 Static / Quasi-Static Torques

Static and/or quasi-static torque is a slowly changing torque.

The calibration of the sensors occurs statically on a calibration device.

The applied torque may accept any value up to the nominal torque.

6.4 Dynamic Torques

6.4.1 General

The static calibration procedure of torque sensors is also valid for dynamic applications.

Note: The frequency of torques must be smaller than the natural frequency of the mechanical measurement setup.

The band width of alternating torque must be limited to 70 % of the nominal torque.

6.4.2 Natural Resonances

Estimate of the mechanical natural frequencies:

$$f_0 = \frac{1}{2 \cdot \pi} \cdot \sqrt{c \cdot \left(\frac{1}{J_1} + \frac{1}{J_2} \right)}$$

f_0 = Natural Frequency in Hz
 J_1, J_2 = Moment of Inertia in kg*m²
 c = Torsional Rigidity in Nm/rad

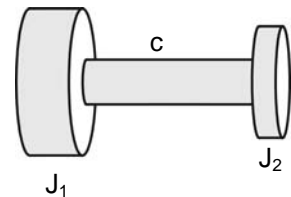

Further methods for the calculation of natural resonances are corresponding purchasable programs or books (e.g. Holzer-Procedure, Dubbel, Taschenbuch für den Maschinenbau, Springer Verlag)



An operation of the device in natural resonance can lead to permanent damages.

6.5 Speed Limits

The maximum speed indicated in the data sheet may not be exceeded in any operating state..

6.6 Disturbance Variables

By disturbances, measured value falsifications can occur by

- Vibrations,
- Temperature gradients,
- Temperature changes,
- Arising disturbance variables during operation, e.g. imbalance,
- Electrical disturbances,
- Magnetic disturbances,
- EMC (electromagnetic disturbances),

Therefore avoid these disturbance variables by decoupling of vibrations, covers, etc.



7 Maintenance

7.1 Maintenance Schedule

Action	Frequency	Date	Date	Date
Control of cables and connectors	1x p.a.			
Calibration	< 26 months			
Control of fixation (flanges, shafts)	1x p.a.			
Have bearings exchanged by Lorenz Messtechnik GmbH	20000 hrs operating time			

7.2 Trouble Shooting

This chart is used for searching for the most frequent errors and their elimination

Problem	Possible Cause	Trouble Shooting
No signal	No sensor excitation	<ul style="list-style-type: none"> • Outside of permissible range • Connect excitation • Cable defect • No mains supply
	Signal output connected wrong	<ul style="list-style-type: none"> • Connect output correctly • Evaluation electronics defect
Sensor does not react to torque	Shaft not clamped	<ul style="list-style-type: none"> • Clamp correctly
	No power supply	<ul style="list-style-type: none"> • Outside of permissible range • Connect supply • Cable defect • No mains supply
	Cable defect	<ul style="list-style-type: none"> • Repair cable
	Connector connected wrong	<ul style="list-style-type: none"> • Connect correctly
Signal has dropouts	Axial position rotor to stator outside of tolerance	<ul style="list-style-type: none"> • Align rotor
	Cable defect	<ul style="list-style-type: none"> • Repair cable
Zero point outside of tolerance	Cable defect	<ul style="list-style-type: none"> • Repair cable
	Shaft mounted distorted	<ul style="list-style-type: none"> • Mount correctly
	Distorted shaft string	<ul style="list-style-type: none"> • Release from distortion
	Strong lateral forces	<ul style="list-style-type: none"> • Reduce lateral forces
	Distorted flanges	<ul style="list-style-type: none"> • Check evenness of flange-surfaces
	Shaft overloaded	<ul style="list-style-type: none"> • Send to manufacturer
Wrong torque indication	Calibration not correct	<ul style="list-style-type: none"> • Re-calibrate
	Sensor defect	<ul style="list-style-type: none"> • Repair by manufacturer
	Torque shunt	<ul style="list-style-type: none"> • Eliminate shunt
Oscillations	Alignment of shaft not correct	<ul style="list-style-type: none"> • Align correctly
	Unbalance	<ul style="list-style-type: none"> • Balance the corresponding parts

8 Decommission

All sensors must be dismantled professionally. Do not strike sensor housings with tools. Do not apply bending moments on the sensor, e.g. through levers. The torque sensor must be supported to avoid falling down during the dismantling.

9 Transportation and Storage

The transportation of the sensors must occur in suitable packing.

For smaller sensors, stable cartons which are well padded are sufficient (e.g., air cushion film, epoxy crisps, paper shavings). The sensor should be tidily packed into film so that no packing material can reach into the sensor (ball bearings).

Larger sensors should be packed in cases.



9.1 Transportation

Only release well packed sensors for transportation. The sensor should not be able to move back and forth in the packing. The sensors must be protected from moisture.
Only use suitable means of transportation.

9.2 Storage

The storage of the sensors must occur in dry, dust-free rooms, only.
Slightly lubricate shafts and flanges with oil before storing (rust).

10 Disposal

The torque sensors must be disposed according to the valid provisions of law.
For this, see our "General Terms and Conditions" www.lorenz-sensors.com

11 Calibration

At the time of delivery, torque sensors have been adjusted and tested with traceable calibrated measuring equipment at factory side. Optionally, a calibration of the sensors can be carried out.

11.1 Proprietary Calibration

Acquisition of measurement points and issuing of a calibration protocol Traceable calibrated measuring equipment is being used for the calibration. The sensor data are being checked during this calibration.

11.2 DKD-Calibration

The calibration of the sensor is carried out according to the guidelines of the DKD. The surveillance of the calibrating-laboratory takes place by the DKD. At this calibration, the uncertainty of measurement of the torque measuring instrument is determined. Further information can be obtained from Lorenz Messtechnik GmbH.

11.3 Re-Calibration

The recalibration of the torque sensor should be carried out after 26 months at the latest.
Shorter intervals are appropriate:

- Overload of the sensor
- After repair
- After inappropriate handling
- Demand of high-quality standards
- Special traceability requirements

12 Data Sheet

See www.lorenz-sensors.com

13 Literature

Dubbel, Taschenbuch für den Maschinenbau, Springer Verlag