

AC Solid State Relay

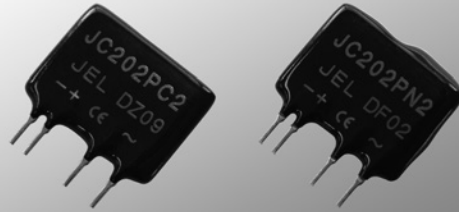

JCP SERIES



Features

- Small size, Resin casted molding type
- Max. load current at 1.7A
- Available for PCB high-density packaging
- Dielectric strength between input and output at 2,500V/1 min.
- UL standard approved

Type Information

J C 2 0 2 P C 2			
Standard load voltage 2 : 100V, 200V	Max. load current 0.2 : 1.7A	Zero-cross-circuit PC : Built-in PN : Not Built-in	Special function None : No input resistance and snubber circuit 1 : No snubber circuit 2 : With input resistance and snubber circuit

Characteristics

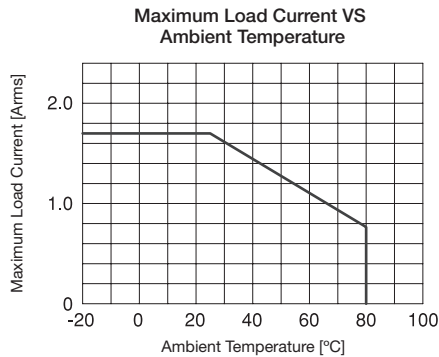

※ Description in the catalogue is subject to change without notice. Please read the specifications thoroughly before using.
 ※ Please contact JEL SYSTEM for further information.

Dimensions (mm)

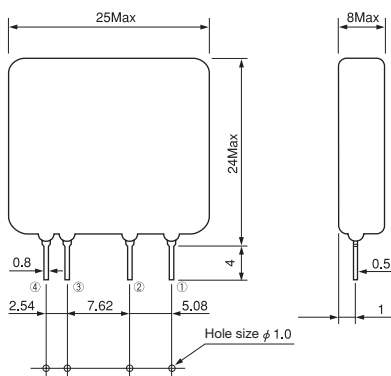

Dimensions For PCB Design

Equivalent Circuit

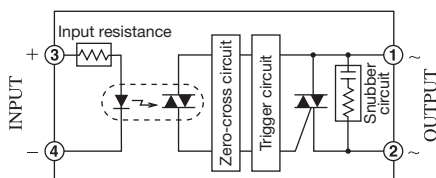

Model	Zero-cross	Input resistance	Snubber circuit
JC202PC	○	×	×
JC202PC1	○	○	×
JC202PC2	○	○	○
JC202PN	×	×	×
JC202PN1	×	○	×
JC202PN2	×	○	○

※ Description in the catalogue is subject to change without notice. Please read the specifications thoroughly before using.
 ※ Please contact JEL SYSTEM for further information.

■ Ratings

(Ta = 25 °C)

	Item	Symbols	JC202 PC2	JC202 PC1	JC202 PC	JC202 PN2	JC202 PN1	JC202 PN	Units
Output	Rated Load Voltage	—	120、240						V _{ACrms}
	Maximum Load Current	I _{OMAX}	1.7						A _{ACrms}
	Maximum Load Voltage	V _{OMAX}	280						V _{ACrms}
	Peak Repetitive Off State Voltage	V _{DRM}	600						V
	Peak 1 Cycle Surge Current	I _{SURGE}	30 (60Hz)						A
	Frequency	f	50、60						Hz
Input	Maximum Input Voltage (Current)	V _{IMAX}	8		(50mA)		8	(50mA)	V _{DC}
	Input Impedance	R _{IN}	180 ± 20 %		—		180 ± 20 %	—	Ω
General	Dielectric Strength	V _{ISO}	2,500/1 min.(Between input and output)						V _{ACrms}
	Isolation Resistance	R _{ISO}	10 ¹⁰ and above DC500V(Between input and output)						Ω
	Operating Temperature Range	T _{OPR}	- 20 ~ + 80						°C
	Storage Temperature Range	T _{STG}	- 30 ~ + 100						°C

■ Electrical Characteristics

(Ta = 25 °C)

	Item	Symbols	JC202 PC2	JC202 PC1	JC202 PC	JC202 PN2	JC202 PN1	JC202 PN	Units
Output	Load Voltage Range	V _O	35 ~ 280						V _{ACrms}
	Off State Leakage Current	I _{LEK}	2.0 and below (V _O = 200V)	0.1 and below (V _O = 200V)		2.0 and below (V _O = 200V)	0.1 and below (V _O = 200V)		mA _{ACrms}
	On State Voltage Drop	V _{SAT}	1.5 and below						V _{ACrms}
	Minimum Load Current	I _{OMIN}	10						mA
Input	Input Voltage (Current) Range	V _I	4 ~ 8		(10~50mA)		4 ~ 8	(10~50mA)	V _{DC}
	Operate Voltage (Current)	V _P	4 and below		(10mA and below)		4 and below	(10mA and below)	V _{DC}
	Release Voltage (Current)	V _D	1 and above		(1mA and above)		1 and above	(1mA and above)	V _{DC}
General	Operate Time	T _{ON}	1/2 Cycle + 1ms and below			1ms and below			/
	Release Time	T _{OFF}	1/2 Cycle + 1ms and below						/
	Capacitance	C _{IO}	15 and below						PF
	Zero Cross Turn On		Built In			Not Built In			/
	Approved Standards		UL						/

※ Description in the catalogue is subject to change without notice. Please read the specifications thoroughly before using.

※ Please contact JEL SYSTEM for further information.

Peak Surge Current VS Duration

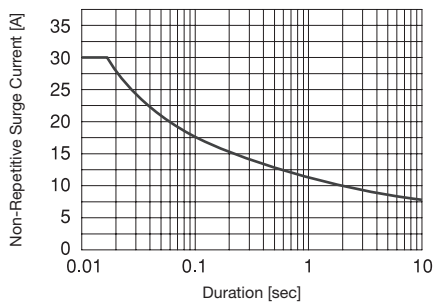

Input Current VS Input Voltage (Typical value)

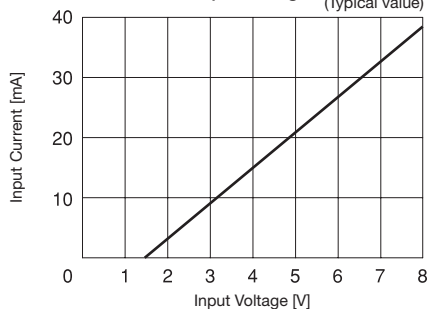

Input Characteristics VS Ambient Temperature (Typical value)

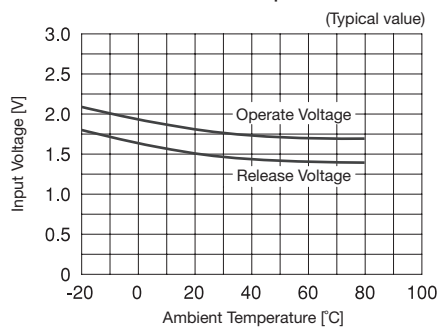

※ Description in the catalogue is subject to change without notice. Please read the specifications thoroughly before using.
 ※ Please contact JEL SYSTEM for further information.